

RIGOL

用户手册

RP1003C/1004C/1005C/1006C

电流探头

2020 年 9 月
RIGOL TECHNOLOGIES CO., LTD.

保证和声明

版权

© 2020 普源精电科技股份有限公司

商标信息

RIGOL®是普源精电科技股份有限公司的英文名称和商标。

文档编号

UGE19006-1110

声明

- 本公司产品受中国及其它国家和地区的专利（包括已取得的和正在申请的专利）保护。
- 本公司保留改变规格及价格的权利。
- 本手册提供的信息取代以往出版的所有资料。
- 本手册提供的信息如有变更，恕不另行通知。
- 对于本手册可能包含的错误，或因手册所提供的信息及演绎的功能以及因使用本手册而导致的任何偶然或继发的损失，**RIGOL** 概不负责。
- 未经 **RIGOL** 事先书面许可，不得影印、复制或改编本手册的任何部分。

产品认证

RIGOL 认证本产品符合中国国家产品标准和行业产品标准及 ISO9001:2015 标准和 ISO14001:2015 标准，并进一步认证本产品符合其它国际标准组织成员的相关标准。

联系我们

如您在使用此产品或本手册的过程中有任何问题或需求，可与 **RIGOL** 联系：

电子邮箱：service@rigol.com

网址：www.rigol.com







一般安全概要

注意



本产品符合 IEC 61010 安全标准并在出厂前经过安全测试。但使用中的任何不当操作都可能会对操作人员造成伤害甚至危及生命安全，也会对设备造成损坏。因此，使用本产品之前，请确保理解本手册所述的指导说明和注意事项。

安全术语和符号

使用本产品之前，请仔细阅读如下安全注意事项。

	<p>产品上的  符号表示用户在使用相关功能之前须阅读手册中标有  符号的内容。</p> <p>手册中的  符号表示重要信息，用户须阅读该内容后才可使用产品。</p>
	<p>产品上的  符号表示仅可测量符合被测电路电压的绝缘导体。</p>

本手册中如下符号表示重要的注意事项或警告信息。

 危险	<p>表示不正确的操作将导致极端危害，对操作者造成严重伤害或死亡。</p>
 警告	<p>表示不正确的操作将导致重大危害，对操作者造成严重伤害或死亡。</p>
 注意	<p>表示不正确的操作可能对操作者造成伤害或损坏设备。</p>
备注	<p>表示与设备性能或正确操作相关的建议。</p>

目录

保证和声明	I
一般安全概要	II
安全术语和符号	II
安全注意事项	IV
服务	VII
电流探头简介	1
RP1003C/RP1004C 部件总览	2
RP1005C/RP1006C 部件总览	3
部件说明	3
电流探头使用方法	5
测量准备	5
消磁和零位调整	5
测量步骤	7
测量过程中需要注意的事项	10
规格	13
RP1003C/RP1004C	13
RP1005C	14
RP1006C	15
附录	16
附录 1 幅频特性	16
附录 2 最大输入电流与频率的关系	18
附录 3 输入阻抗（典型）	20

安全注意事项

危险

1. 请勿在裸导体附近测量，否则可能会引起短路或遭受电击。只可在对电路电压提供充分绝缘的导线处进行测量。
2. 测量含有高频成分的电流时，请参考**附录2 最大输入电流与频率的关系**。请勿测量超过额定值的电流。
3. 在高频或强磁环境下使用本产品可能导致产品出现异常发热，进而引起火灾、设备损坏或烧坏（见**规格**）。
4. 为避免电击或短路，请遵守如下注意事项。
 - 1) 首先将探头与电源适配器和波形测量仪器连接，然后再将该探头连接至被测的有源电线。
 - 2) 打开传感器时，请勿将被测导体短接。
 - 3) 测量时，请勿损坏仪器的绝缘层。
 - 4) 为避免电击，连接被测导体前，请确保其绝缘层完好无损。连接时，请注意不要损坏被测导体的绝缘层。
 - 5) 本产品应与**RP1000P**电源适配器配合使用。
 - 6) 为避免发生火灾，损坏或烧坏被测对象和设备，测量高频电流或含有高频成分的电流时请关注如下内容：
 - ✧ 涡流损耗可能导致传感器头发热。
 - ✧ 介电加热可能导致电缆绝缘层或其它材料发热。
 - 7) 本探头只可连接至断路器的二次侧。此时，断路器可以避免因短路造成的危害。请勿将本探头连接至断路器的一次侧。此种情况下，短路时无限制的电流将引起严重事故。
 - 8) 对于与本探头连接的波形测量仪器或其它测量仪器，请确保遵守其所有操作注意事项。
 - 9) 当测量仪器的输入端口、机箱或其它输入端之间没有绝缘时，请注意以下几点：如下页图所示，如果信号连接到除本探头所连接的端口之外的其它输入端口上，请勿将该信号的接地端连接至任何非地电势，否则短路电流将从接地端流经**RP1000P**或电流探头，引起电气事故或损坏电流探头。

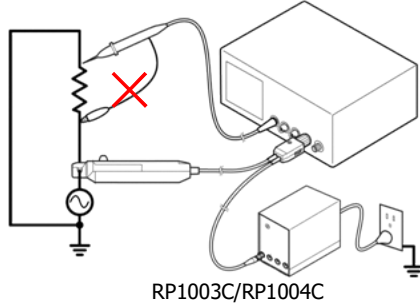

RP1003C/RP1004C

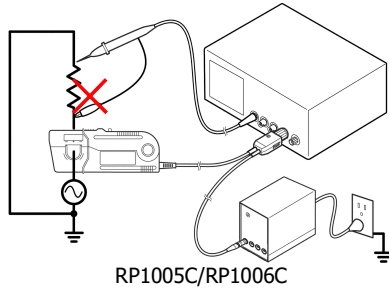

RP1005C/RP1006C

⚠警告

1. 请保持仪器干燥，并在测量时保持双手干燥，以免发生电击。
2. 当探头已连接被测导体时，请勿按下消磁开关（DEMAG）执行消磁操作。否则，可能损坏电路或引起电气事故，进而造成人身伤亡。
3. 确保输入不要超过最大额定电流，以免由于过热而造成设备损坏、短路进而发生触电危险。
4. 测量带电线路时，为防止触电，请穿戴合适的防护装备，如绝缘手套、长靴和安全帽等。

⚠注意

1. 为防止损坏探头，在运输和搬运过程中请注意防震和碰撞，特别要避免跌落。
2. 本探头仅可在室内安装、操作，温度范围在0℃至40℃，相对湿度不大于80%。
3. 保存或使用仪器时，请勿将仪器放置在阳光直射、高温、潮湿或容易发生冷凝的地方，否则，仪器的绝缘性可能会降低从而会影响其性能指标，甚至损坏仪器。
4. 本仪器并非完全防水或防尘，因此，请勿在潮湿或多尘的环境下使用，以免损坏

仪器。

5. 电流传感器头为精密组合件，包含一个模制元件、铁氧体磁芯和霍尔效应元件。当环境温度突变、受到机械拉力或撞击时，电流传感器可能会损坏。因此使用时需格外小心。
6. 电流传感器头的齿合面经过了精细的研磨，使用仪器时应格外小心，以免划伤齿合面，影响探头的性能。
7. 当电流传感器头的齿合面上落有灰尘时，可能会影响测量结果的准确性。因此，用户需使用干净的软布轻轻擦拭以保持齿合面的清洁。
8. 当电流传感器头的齿合面上落有异物时，可能会产生共振噪音（参考后文关于**共振噪音**的介绍）并影响测量结果的准确性。因此，用户需使用干净的软布轻轻擦拭以保持齿合面的清洁。
9. 请不要过度弯折或拉扯电流传感器电缆和电源电缆，以免损坏电缆。
10. 请勿将静电或其它高压源应用于传感器。否则，可能损坏内部霍尔元件和电路。
11. 清洁探头时，请使用软布蘸取水或温和溶剂轻轻擦拭。请勿使用苯、酒精、丙酮、乙醚、酮、稀释剂或汽油等溶剂擦拭。否则，将造成产品变形或褪色。
12. 接通电源后，除非连接被测导体，其它时间请保持传感器闭合，否则，磁芯部分的齿合面可能会被划伤。
13. 不使用时请闭合传感器头，以免灰尘堆积到齿合面而影响其夹固性能。
14. 请勿踩踏或挤压电缆，以免损坏电缆的绝缘性。
15. 电缆应远离热源，否则其绝缘层将融化，从而造成导线裸露。

备注

当仪器周围存在强磁场（如变压器和高电流导体附近）或强电磁场（如无线电发射机附近）时，测量结果可能不正确。

服务

如需返厂维修，请将探头仔细包装以免其在运输过程中发生破损。包装时，请使用减震材料将探头稳固在包装内。同时，请附上产品故障的详细说明。因运输造成探头损坏，**RIGOL**公司恕不负责。

为了保证电流探头可提供指定精度的正确测量结果，请定期校准探头。如需校准，请与**RIGOL**联系。

电流探头简介

本电流探头直接与波形测量仪器的BNC输入连接器相连,通过传感器头连接被测导体,可轻松捕获电流波形。

主要特色:

- 高精度电流检测
- 简捷的电流测量
- 宽带频率特点
 - RP1003C: DC 至 50MHz
 - RP1004C: DC 至 100MHz
 - RP1005C: DC 至 10MHz
 - RP1006C: DC 至 2MHz
- RP1003C/RP1004C: 设计紧凑, 允许测量小电流
- RP1005C/RP1006C: 导体直径较大允许测量大电流
- 简便的超量程输入保护功能
- 独创的薄膜霍尔效应元件

RP1003C/RP1004C 部件总览



图 1 RP1003C/RP1004C 部件示意图

关于上图中的部件 1 至 7，请参考**部件说明**。

RP1005C/RP1006C 部件总览

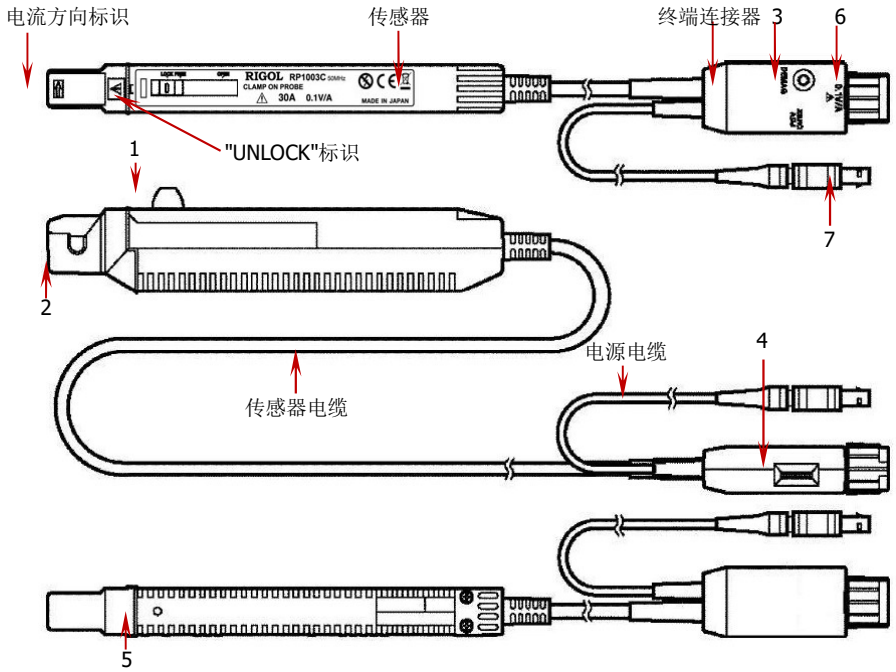

图 2 RP1005C/RP1006C 部件示意图

关于上图中的部件 1 至 7，请参考**部件说明**。

部件说明

1. 滑动开关

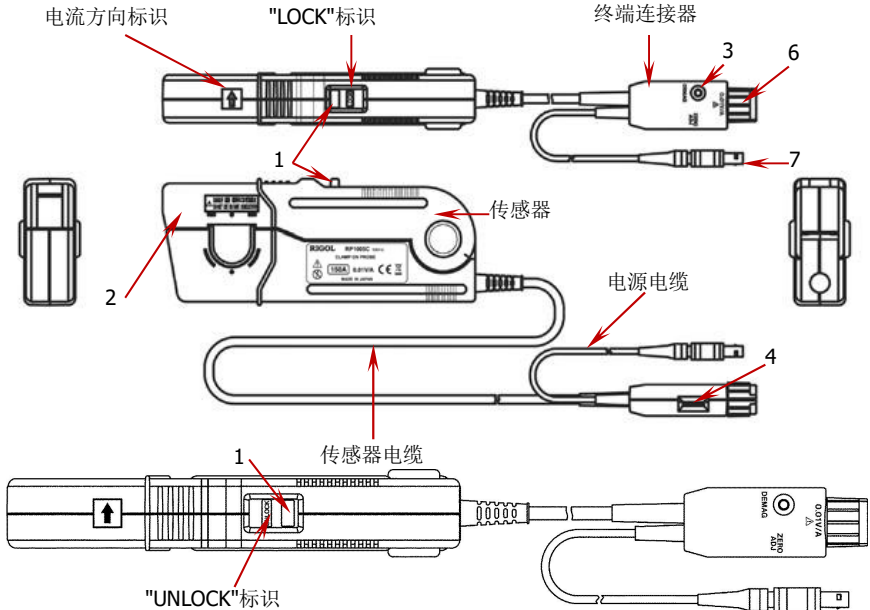
用于打开和锁紧电流传感器。测量被测导体时应锁紧电流传感器，以免发生危险。对于 RP1003C/RP1004C，滑动开关的一侧标有 OPEN、FREE 和 LOCK 三种标识，电流传感器的开关状态与滑动开关所处的位置有关：

- ◇ 当滑动开关处于 OPEN 位置时，电流传感器完全打开，此时可将被测导体连接至电流传感器；
- ◇ 当滑动开关处于 FREE 位置时，电流传感器处于闭合状态但未锁紧；
- ◇ 当滑动开关处于 LOCK 位置时，电流传感器头处于锁紧状态，此时，UNLOCK 标识被遮挡。

对于 RP1005C/RP1006C，滑动开关上面标有 LOCK 和 UNLOCK 标识，当开关上面显示 LOCK 标识并且 UNLOCK 标识消失时，电流传感器处于锁紧状态。

2. 电流传感器头

用于连接被测导体以执行实际电流测量。电流传感器头为精密装置，包含一个模制元件、铁氧体磁芯和霍尔效应元件。当环境温度突变、受到机械拉力或撞击时，可能会损坏电流传感器，因此使用时需格外小心。

3. 消磁开关 (DEMAG)

仪器上电、掉电或当输入电流过大时，磁芯会被磁化，使用消磁开关可为磁芯消磁。进行测量前须执行消磁操作。整个消磁操作持续 1 秒 (RP1003C/RP1004C) 或 3 秒 (RP1005C/RP1006C) 左右。该过程中，电流探头将输出一个消磁波形。

4. 零位调整表盘 (ZERO ADJ)

使用零位调整表盘可以修正由于仪器的直流电压偏移或温度漂移产生的影响。开始测量时，执行完消磁操作后，应该进行调零，将基线调整至零位。

5. 粗调调整器 (仅适用于 RP1003C/RP1004C)

仅当无法在零位调整表盘范围内进行调节时使用。可以使用绝缘螺丝刀 (如陶瓷螺丝刀) 通过该调整器进行调节。

6. 输出连接器

被测导体的电流波形将以恒定的增益通过该连接器输出至波形测量仪器。该输出连接器可连接至波形测量仪器的 BNC 输入连接器。

备注

- 因电流探头输出阻抗为 25Ω (RP1003C/RP1004C) 或 7Ω (RP1005C/RP1006C)，因此，本电流探头只可与输入阻抗至少为 $1\text{ M}\Omega$ 的波形测量仪器相连接。若使用输入阻抗为 50Ω 的波形测量仪器进行测量，则会导致测量结果不准确。
- 若使用 BNC 转香蕉插头或其它类似连接器连接除 BNC 连接器之外的输入端口，请注意保证极性正确。
- 转动输出连接器的卡圈，并检查卡圈是否锁紧。

7. 电源插头

将该电源插头连接至电源适配器的相应插孔，为电流探头的终端连接器提供电源。

电流探头使用方法

使用电流探头执行测量之前，请仔细阅读**安全注意事项**一节。

测量准备

1. 准备一台 RP1000P 电源适配器和一台波形测量仪器。

⚠注意

打开电源适配器之前，请确保所使用的电源电压与电源适配器后面板上所标注的供电电压相匹配。若不匹配，则可能会损坏电源适配器，并发生电气事故。

2. 关闭电源适配器的开关，将电源适配器连接至交流电源。
3. 将电流探头的电源插头连接至电源适配器。

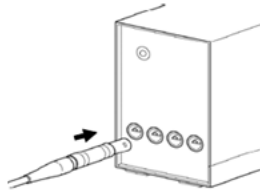

4. 打开电源适配器的开关，并检查电源指示灯是否点亮。
5. 打开电流探头后，请等待至少**30分钟**。刚接通电源时，由于预热等因素，将产生明显的零点漂移，因此，为保证测量的准确性，执行测量前，应将电流探头预热**30分钟**以上。

消磁和零位调整

1. 如果波形测量仪器的输入为地电平，应将其基线调整至零位。
2. 将波形测量仪器的输入耦合设置为直流。
3. 将电流探头的输出连接器连接至波形测量仪器的输入端。转动输出连接器的卡圈，如下图所示，并检查卡圈是否锁紧。

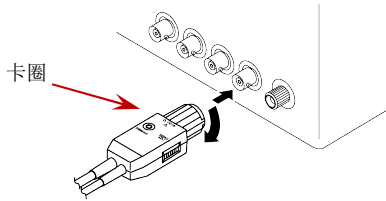

⚠注意

- 断开输出连接器与波形测量仪器的连接时，首先解除锁紧，然后将连接器拔出。未解除锁紧而直接拔出或拉扯电缆线可能损坏终端连接器。
- 若使用 BNC 转香蕉插头或其它类似连接器连接除 BNC 连接器之外的输入端，请注意保证极性正确。
- 当电流探头的电流传感器连接被测导体时，请勿进行消磁操作，因为消磁操作会导致电流流入导体，可能会损坏被测电路的器件。

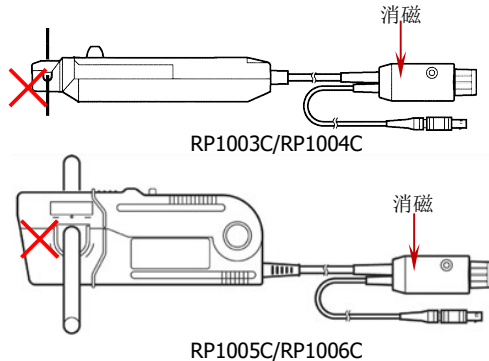

- 鉴于上述考虑，为电流探头供电前，请确保电流探头未连接被测导体。接通电流探头的电源将产生消磁波形。
4. 请确保电流传感器处于锁紧状态（对于 RP1003C/RP1004C，滑动开关应处于 LOCK 位置；对于 RP1005C/RP1006C，滑动开关上面显示 LOCK 标识且无 UNLOCK 标识显示）。
 5. 按下终端连接器上的消磁开关（DEMAG）。
 6. 拨动终端连接器上的零位调整表盘，将基线调至零位。

备注

对于 RP1003C/RP1004C，当无法实现步骤 6 中所提及的零位调整，可以通过粗调调整器将基线调整至零位调整表盘可调节的范围内。

调整粗调调整器时，请勿用力过大，否则，可能导致调整器脱落。请使用符合如下要求的一字螺丝刀：螺丝刀头由陶瓷等非导电物质制成，厚 0.4mm，宽 1.8mm，长度不小于 10mm。

测量步骤

1. 检查并确保测量系统安全且上述准备工作已就绪。
2. 按下图箭头所示方向拨动滑动开关打开电流传感器（对于 RP1003C/RP1004C，滑动开关处于 OPEN 位置；对于 RP1005C/RP1006C，滑动开关上面显示 UNLOCK 标识，LOCK 标识消失）。

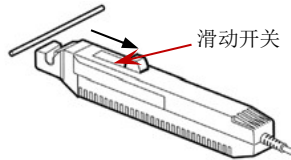

3. 调整电流传感器，使其电流方向标识与待测导体中的电流方向一致，使用电流传感器连接待测导体，并使待测导体位于孔中心。
4. 按下图箭头所示方向拨动滑动开关将电流传感器锁紧（对于 RP1003C/RP1004C，滑动开关应处于 LOCK 位置；对于 RP1005C/RP1006C，首先应该上下按压电流探头闭合电流传感器，然后拨动滑动开关直至上面显示 LOCK 标识，UNLOCK 标识消失）。

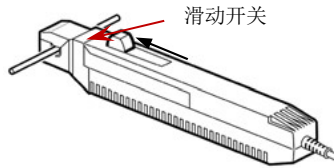

5. 此时，您可以查看电流波形。RP1003C/RP1004C 的输出增益为 0.1V/A，RP1005C/RP1006C 的输出增益为 0.01V/A。您可以通过波形测量仪器的电压灵敏度计算出电流灵敏度。例如，对于 RP1003C，波形测量仪器的电压灵敏度为 10mV/div，则电流灵敏度为 $(10\text{mV}/\text{div})/(0.1\text{V}/\text{A})=100\text{mA}/\text{div}$ 。

备注

- 使用电流探头时，请注意，两个已连接被测导体的探头可能不可同时连接到 RP1000P 电源适配器，具体取决于被测电流。
- 电流探头的电流消耗取决于被测电流。在一个电源适配器上同时连接多个

电流探头时，请确保连接至电源适配器上的电流探头的电流消耗总量不超过电源适配器的额定输出电流。下图为输出电流与电流消耗之间的关系曲线：

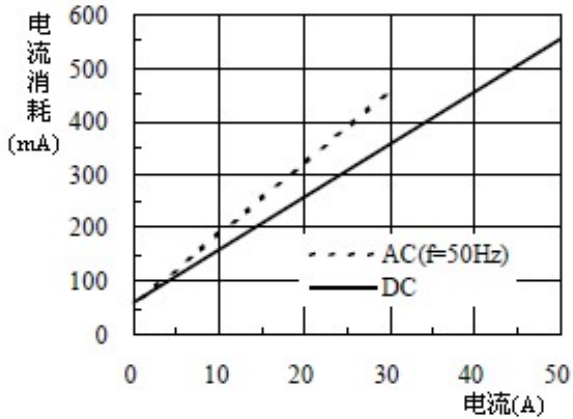

RP1003C

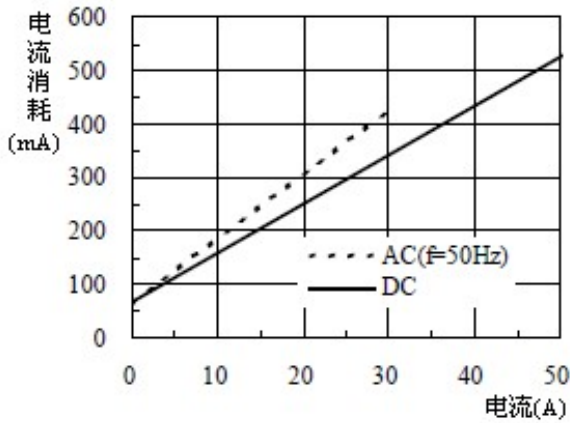

RP1004C

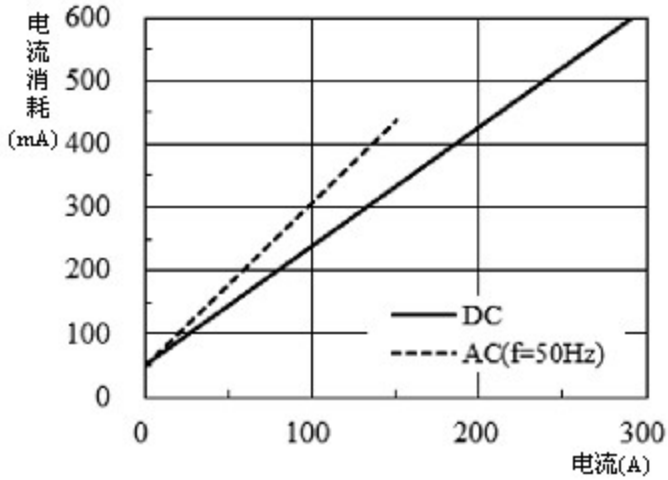

RP1005C

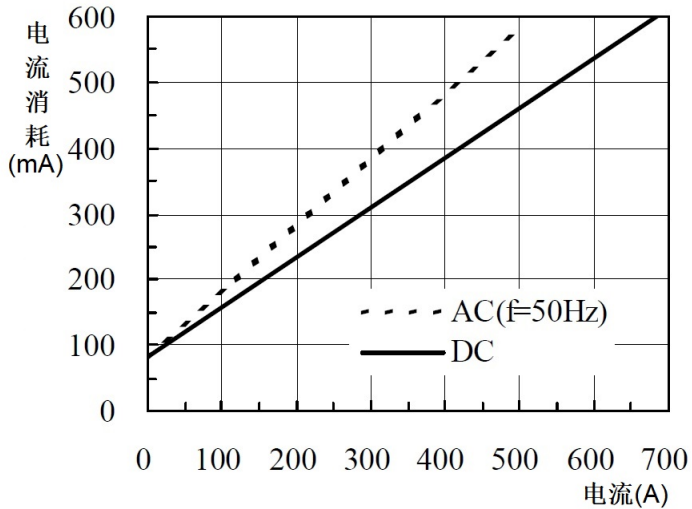

RP1006C

注：电流消耗为正负电流消耗代数之和。

测量过程中需要注意的事项

⚠注意

1. 最大连续输入范围是基于测量过程中仪器内部所产生的热量而定的。注意：输入电流不可超过该范围，否则可能损坏电流探头。
2. 参考附录 2 最大输入电流与频率的关系。最大额定电流为标准条件下正弦波输入时的推荐值。当环境温度增加或被测电流含有其它频率成分时将增加自发热。因此，即使电流探头工作在低于额定电流的条件下，也可能由于自发热而损坏。
3. 如果输入电流超出最大连续输入范围，可能导致仪器内部温度过高而启动内置的保护电路功能，该功能会阻碍正常的输出。此时，请立即断开电流传感器与被测导体的连接或将输入电流降低至 0，待电流传感器充分冷却后，方可重新进行操作。
4. 测量 1kHz 以上（含）的电流将导致电流传感器头温度上升。发生此现象是因为传感头的自发热。在这种情况下，内置的保护电路功能不会被激活。请注意避免事故发生，如灼伤、短路及设备损坏。
5. 即使输入电流未超出额定连续输入范围，但长时间的连续输入也会启动保护电路功能以避免电流传感器发热引起的设备损坏。
6. 当环境温度过高时，即使输入电流低于额定连续输入范围，也可能会启动内置的保护电路功能。
7. 如果输入电流多次超出额定最大连续输入范围而使保护电路反复启动，将会造成设备损坏。
8. 最大输入范围由**最大连续输入范围**确定，也由**最大峰值电流值**确定。请确保输入不大于最大连续输入有效值范围。
9. 由于周围导体中的电流可能会使电流传感器温度升高，因此，请勿将带有 10kHz 或更高频率电流的导体放在电流传感器头周围，以免损坏电流传感器，如下图所示。

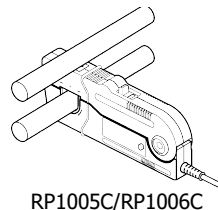
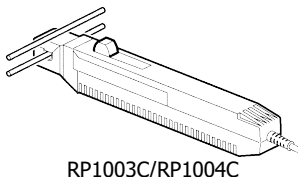

10. 请使用滑动开关打开电流传感器头。对于 RP1003C/RP1004C，传感头锁紧时，如果其上芯被强制打开，则有可能损坏滑动开关的内部结构。

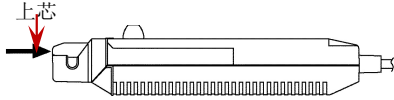

备注

1. 刚接通电源时，由于自发热，将产生明显的零点漂移，因此，为防止这种情况的发生，进行测量前，应将电流探头预热 30 分钟以上。
2. 执行连续测量时，请注意由于环境温度等因素而引起的零点漂移。
3. 在某些情况下，将电源插头连接至通电的电源适配器时，可能会产生震荡，该情况不属于仪器故障，可通过开关传感器的卡钳消除震荡并使操作恢复正常。
4. 基于被测电流的幅值和频率，传感器头可能会产生共振噪音。消磁过程中也可能产生共振噪音。这不属于仪器故障。
5. 若电流传感器头的齿合面沾有异物，这将在电流传感器的上层和下层之间产生微小缝隙，这种情况下，电流传感器头将产生共振噪音。因此，请在测量之前使用本手册所述清洁方法清除齿合面上的所有异物。
6. 使用过程中，若共振噪音的音量增大，表示电流传感器的上层和下层之间的缝隙变大。因此，电流传感器的特性将改变。此时，建议您校准探头。
7. 按下消磁开关（DEMAG）将从探头输出一个消磁波形。该波形可能并不以零电压线对称，该情况不属于仪器故障。
8. 请将被测导体连接至电流传感器的钳孔中心，否则，将影响测试结果。
9. 执行电流测量时，请确保传感器头已锁紧（对于 RP1003C/RP1004C，滑动开关应处于 LOCK 位置；对于 RP1005C/RP1006C，首先应该上下按压电流探头闭合电流传感器，然后拨动滑动开关直至上面显示 LOCK 标识，UNLOCK 标识消失）。若电流传感器没有完全闭合，将无法得到准确的测量结果。
10. 当仪器周围存在强磁场（如变压器和高电流导体附近）或强电磁场（如无线电发射机附近）时，测量结果可能不正确。
11. 频率较高时，共模噪声可能会影响电路高压端的测量。此情况下，降低波形测量仪器的频率范围或连接电路的低压端。

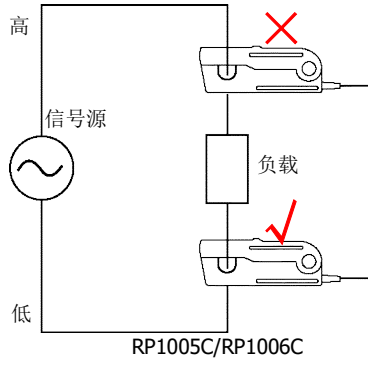
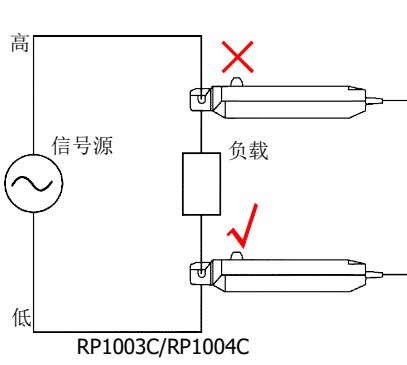

规格

当仪器在规定的操作温度（ $23^{\circ}\text{C}\pm 5^{\circ}\text{C}$ ）下连续运行 30 分钟以上时，以下指标可以得到保证。

RP1003C/RP1004C

带宽	RP1003C: DC 至 50MHz(-3dB), 参考附录 1 幅频特性(RP1003C) RP1004C: DC 至 100MHz(-3dB), 参考附录 1 幅频特性(RP1004C)
上升时间	RP1003C: $\leq 7\text{ns}$ RP1004C: $\leq 3.5\text{ns}$
最大连续输入范围	30Arms, 参考附录 2 最大输入电流与频率的关系 (RP1003C/RP1004C)
最大峰值电流值	50A 峰值, 非连续
增益	0.1V/A
幅度精度	$\pm 1.0\% \text{rdg} \pm 1\text{mV}$, $\leq 30\text{Arms}$ $\pm 2.0\% \text{rdg}$, $\leq 50\text{A}$ 峰值 (DC, 45Hz 至 66Hz, 输入在最大连续输入范围内)
噪声	$\leq 2.5\text{mArms}$ (带宽为 20MHz 的波形测量仪器)
输入阻抗	参考附录 3 输入阻抗 (典型) (RP1003C/RP1004C)
灵敏度的温度系数	$\leq \pm 2\%$ (温度范围 0°C 至 40°C , 输入 50Hz, 30Arms)
最大额定功率	5.3VA
额定供电电压	$\pm 12\text{V} \pm 0.5\text{V}$
操作温度和湿度范围	0°C 至 40°C , 相对湿度 $\leq 80\%$ (无凝结)
储存温度和湿度范围	-10°C 至 50°C , 相对湿度 $\leq 80\%$ (无凝结)
应用场所	室内, 海拔 $\leq 2000\text{m}$, 污染等级 2
外部磁场影响	RP1003C: $\leq 20\text{mA}$ (DC 和 60Hz, 400A/m 磁场) RP1004C: $\leq 5\text{mA}$ (DC 和 60Hz, 400A/m 磁场)
可测量导体的直径	5mm
可测量导体	绝缘导体
精度保证期	1 年 (开/关次数最多可达 1 万次)
电缆长度	传感器电缆: 约 1.5m 电源电缆: 约 1m
外部尺寸	传感器: 约 $175\text{W} \times 18\text{H} \times 40\text{Dmm}$ (不包括突出部分) 终端连接器: 约 $27\text{H} \times 55\text{W} \times 18\text{Dmm}$
重量	RP1003C: 约 230g RP1004C: 约 240g

附件	用户手册, 探头包
安规	EN61010
EMC	EN61326

RP1005C

带宽	DC 至 10MHz(-3dB), 参考附录 1 幅频特性 (RP1005C)
上升时间	≤35ns
最大连续输入范围	150Arms, 参考附录 2 最大输入电流与频率的关系 (RP1005C)
最大峰值电流值	300A 峰值, 非连续 500A 峰值, 脉宽≤30μs
增益	0.01V/A
幅度精度	±1.0%rdg±1mV, ≤150Arms ±2.0%rdg, 150A 至 300A 峰值 (DC, 45Hz 至 66Hz)
噪声	≤25mArms (带宽为 20MHz 的波形测量仪器)
输入阻抗	参考附录 3 输入阻抗 (典型) (RP1005C)
灵敏度的温度系数	≤±2%(温度范围 0℃ 至 40℃, 输入 55Hz, 150Arms)
最大额定功率	5.5VA (在最大连续输入范围内)
额定供电电压	±12V±1V
操作温度和湿度范围	0℃ 至 40℃, 相对湿度≤80% (无凝结)
储存温度和湿度范围	-10℃ 至 50℃, 相对湿度≤80% (无凝结)
应用场所	室内, 海拔≤2000m, 污染等级 2
精度保证期	1 年 (开/关次数最多可达 1 万次)
外部磁场影响	≤150mA (DC 或 60Hz, 400A/m 磁场)
可测量导体直径	20mm
可测量导体	绝缘导体
电缆长度	传感器电缆: 约 2m 电源电缆: 约 1m
外部尺寸	传感器: 约 176W X 69H X 27Dmm 终端连接器: 约 27H X 55W X 18Dmm
重量	约 500g
附件	用户手册, 探头包
安规	EN61010
EMC	EN61326

RP1006C

带宽	DC 至 2MHz(-3dB), 参考附录 1 幅频特性 (RP1006C)
上升时间	≤175ns
最大连续输入范围	500Arms, 参考附录 2 最大输入电流与频率的关系 (RP1006C)
最大峰值电流值	700A 峰值, 非连续
增益	0.01V/A
幅度精度	±1.0%rdg±5mV, ≤500Arms ±2.0%rdg, ≤700A 峰值 (DC, 45Hz 至 66Hz)
噪声	≤25mArms (带宽为 20MHz 的波形测量仪器)
输入阻抗	参考附录 3 输入阻抗 (典型) (RP1006C)
灵敏度的温度系数	≤±2%(温度范围 0℃至 40℃, 输入 50Hz, 500Arms)
最大额定功率	7.2VA (在最大连续输入范围内)
额定供电电压	±12V±0.5V
操作温度和湿度范围	0℃至 40℃, 相对湿度≤80% (无凝结)
储存温度和湿度范围	-10℃至 50℃, 相对湿度≤80% (无凝结)
应用场所	室内, 海拔≤2000m, 污染等级 2
精度保证期	1 年 (开/关次数最多可达 1 万次)
外部磁场影响	≤800mA (DC 或 60Hz, 400A/m 磁场)
可测量导体直径	20mm
可测量导体	绝缘导体
电缆长度	传感器电缆: 约 2m 电源电缆: 约 1m
外部尺寸	传感器: 约 176W X 69H X 27Dmm 终端连接器: 约 27H X 55W X 18Dmm
重量	约 520g
附件	探头包
安规	EN61010
EMC	EN61326

附录

附录 1 幅频特性

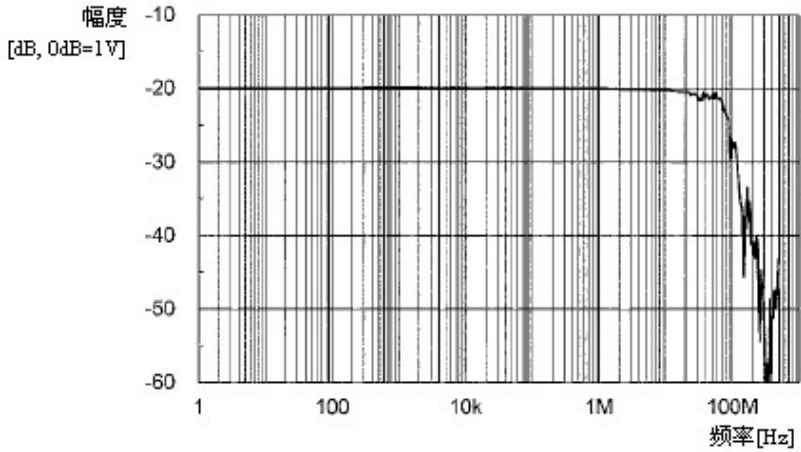

RP1003C

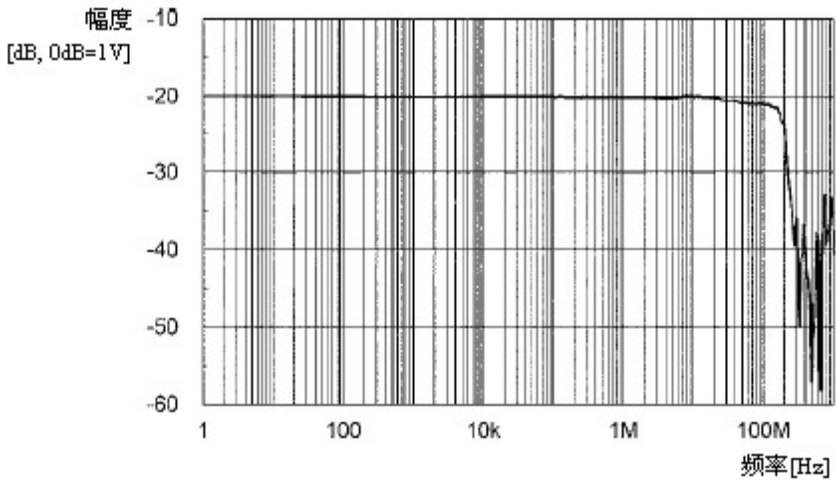

RP1004C

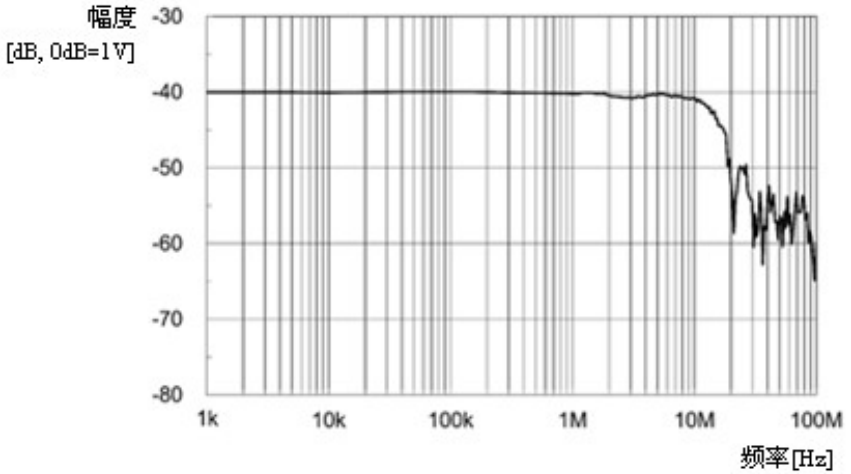

RP1005C

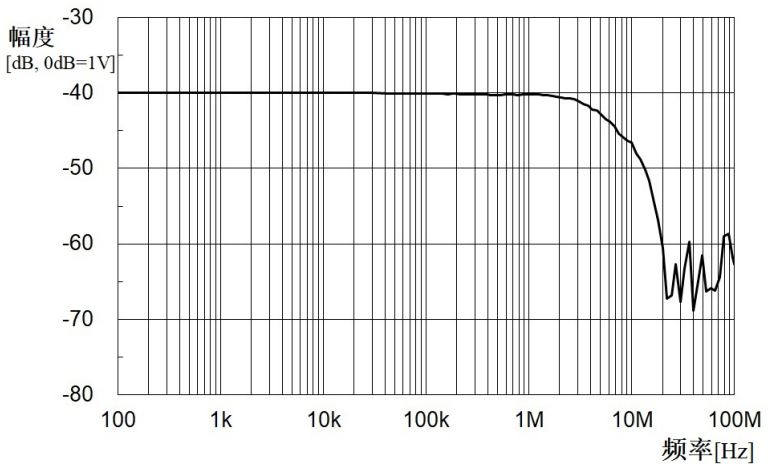

RP1006C

附录 2 最大输入电流与频率的关系

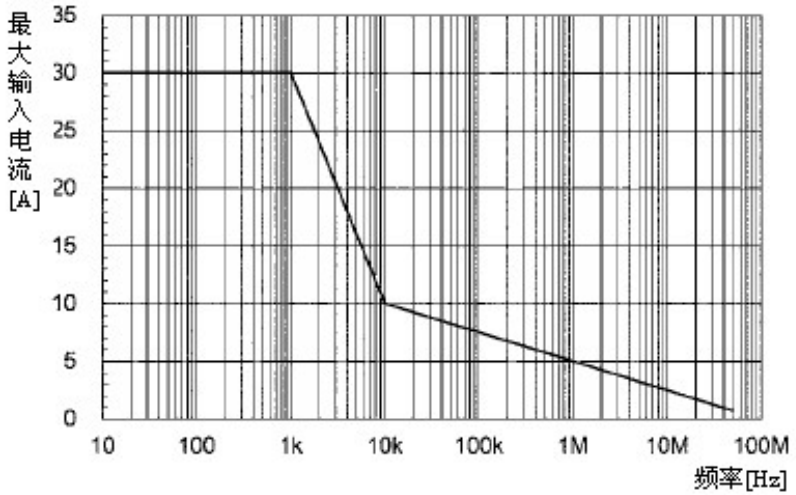

RP1003C

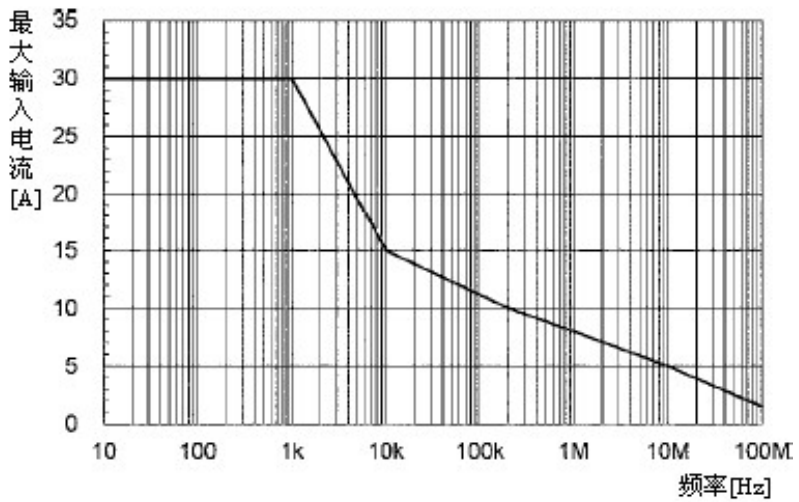

RP1004C

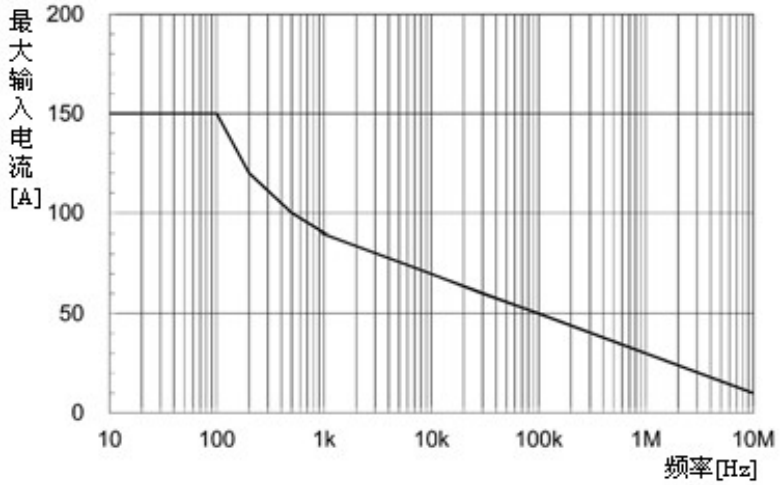
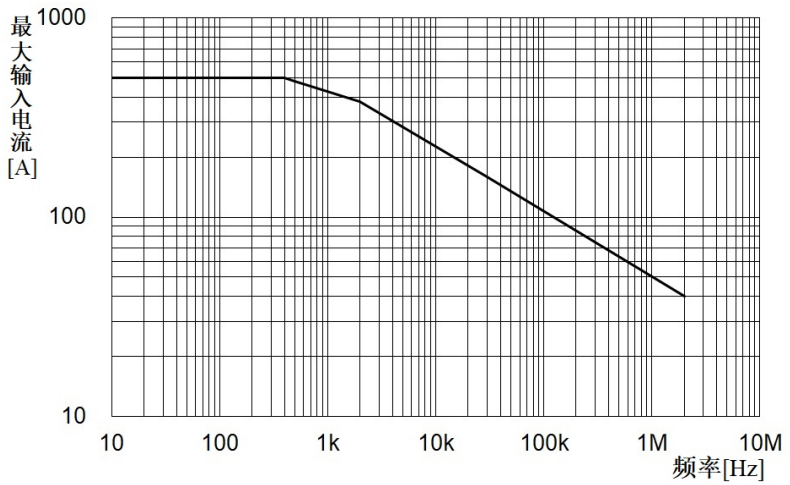
**RP1005C****RP1006C**

附录 3 输入阻抗（典型）

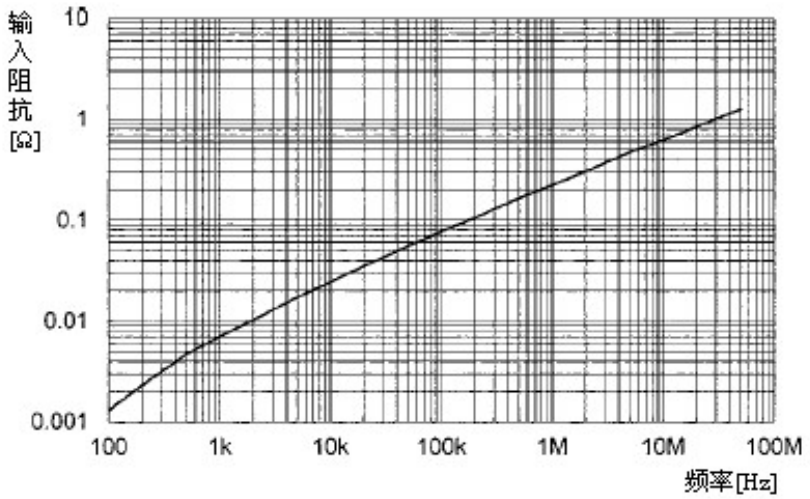

RP1003C

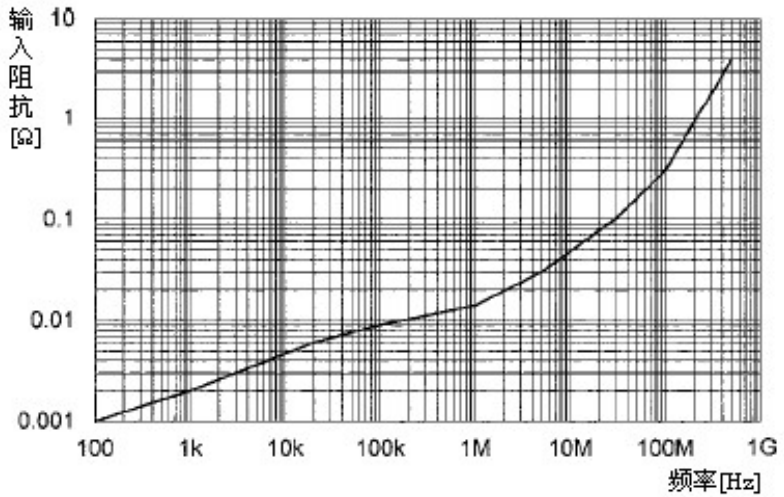

RP1004C

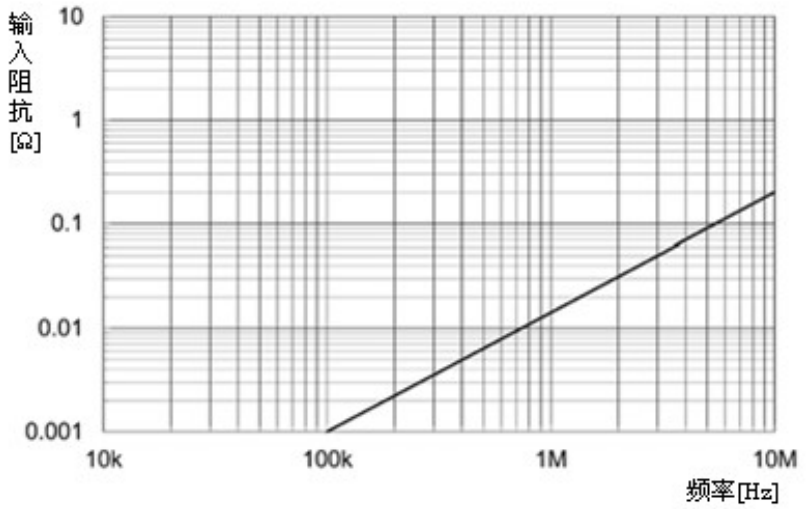
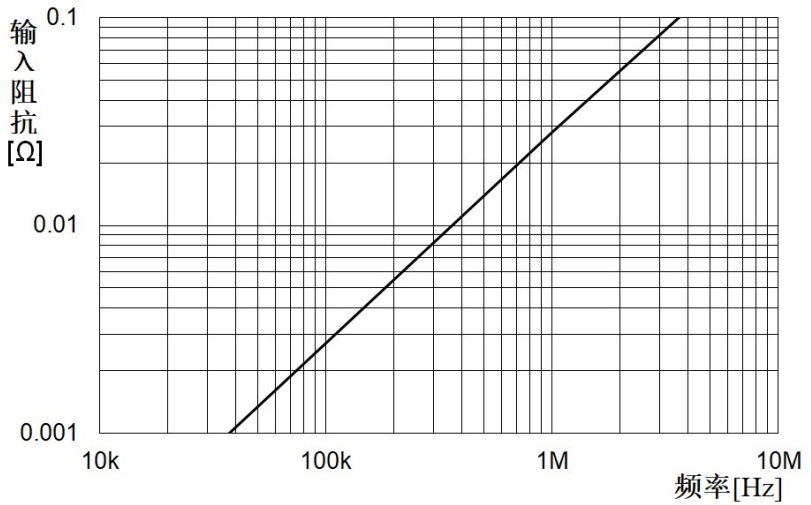
**RP1005C****RP1006C**

RIGOL

User Guide

RP1003C/1004C/1005C/1006C Current Probe

**Sept. 2020
RIGOL TECHNOLOGIES CO., LTD.**

Guaranty and Declaration

Copyright

© 2020 **RIGOL** TECHNOLOGIES CO., LTD. All Rights Reserved.

Trademark Information

RIGOL® is the trademark of **RIGOL** TECHNOLOGIES CO., LTD.

Publication Number

UGE19106-1110

Notices

- **RIGOL** products are covered by P.R.C. and foreign patents, issued and pending.
- **RIGOL** reserves the right to modify or change parts of or all the specifications and pricing policies at the company's sole decision.
- Information in this publication replaces all previously released materials.
- Information in this publication is subject to change without notice.
- **RIGOL** shall not be liable for either incidental or consequential losses in connection with the furnishing, use, or performance of this manual, as well as any information contained.
- Any part of this document is forbidden to be copied, photocopied, or rearranged without prior written approval of **RIGOL**.

Product Certification

RIGOL guarantees that this product conforms to the national and industrial standards in China as well as the ISO9001:2015 standard and the ISO14001:2015 standard. Other international standard conformance certifications are in progress.

Contact Us

If you have any problem or requirement when using our products or this manual, please contact **RIGOL**.

E-mail: service@rigol.com

Websites: www.rigol.com







General Safety Summary

CAUTION



This device is designed to comply with IEC 61010 Safety Standards, and has been thoroughly tested for safety prior to shipment. However, mishandling during use could result in injury or death, as well as damage to the device. Ensure that you understand the instructions and precautions in the manual before use.

Safety Terms and Symbols

Before using the device, be sure to carefully read the following safety notes.

	<p>The  symbol printed on the device indicates that the user should refer to a corresponding topic in the manual (marked with the  symbol) before using the relevant function.</p> <p>In the manual, the  symbol indicates particularly important information that the user should read before using the device.</p>
	<p>The  symbol printed on the device indicates that only insulated conductors suited to the voltage of the circuit under test can be measured.</p>

The following symbols in this manual indicate the importance of cautions and warnings.

 DANGER	<p>Indicates that incorrect operation presents an extreme hazard that could result in serious injury or death to the user.</p>
 WARNING	<p>Indicates that incorrect operation presents a significant hazard that could result in serious injury or death to the user.</p>
 CAUTION	<p>Indicates that incorrect operation presents a possibility of injury to the user or damage to the device.</p>
NOTE	<p>Indicates advisory items related to performance or correct operation of the device.</p>

Contents

Guaranty and Declaration	I
General Safety Summary	II
Safety Terms and Symbols	II
Safety Precautions	IV
Service	VII
Current Probe Overview	1
RP1003C/RP1004C Parts Overview	2
RP1005C/RP1006C Parts Overview	3
Parts Introductions	4
To Use the Current Probe	6
Preparations for Measurement	6
Demagnetizing and Zero Adjustment	6
Measurement Procedure	8
Precautions for Measurement	10
Specifications	14
RP1003C/RP1004C	14
RP1005C	15
RP1006C	16
Appendix	18
Appendix 1 Amplitude-frequency Characteristics	18
Appendix 2 Relation between Max Input Current and Frequency	20
Appendix 3 Input Impedance (Typical)	22

Safety Precautions

DANGER

1. Do not measure around a bare conductor. Doing so may result in short-circuit or electric shock. Take measurements at a location on an insulated wire where there is sufficient insulation for the circuit voltage.
2. When measuring current that contains high-frequency components, refer to **Appendix 2 Relation between Max Input Current and Frequency**. Never measure any current that exceeds the rated current.
3. Using the probe in strong high-frequency magnetic fields may cause the device to become abnormally hot, resulting in fire, equipment damage, or burns (see **Specifications**).
4. Observe the following to avoid electric shock and short circuit.
 - 1) Connect the probe to the power adapter and waveform measurement instrument first, and then connect the probe to the active lines to be measured.
 - 2) When the sensor is opened, do not short circuit the conductor being measured.
 - 3) Be careful to avoid damaging the insulation surface while taking measurements.
 - 4) Before clamping the conductor being measured, make sure that the insulation on the conductor is undamaged. Also, take care not to damage the insulation when clamping the conductor. Any damage to the insulation could cause an electric shock.
 - 5) The probe is made for use with the RP1000P power adapter.
 - 6) To prevent fire, avoid damage or burns of the measurement object/device, pay attention to the following cautions when measuring high-frequency currents or currents that contain high-frequency components:
 - ◇ Eddy current loss may cause heating of the sensor head.
 - ◇ Dielectric heating may cause heating of cord insulation and other materials.
 - 7) The probe should only be connected to the secondary side of a breaker, so the breaker can prevent an accident if a short circuit occurs. Connections should never be made to the primary side of a breaker, because unrestricted current flow could cause a serious accident if a short circuit occurs.
 - 8) Be sure to observe all operating precautions for the waveform measurement instrument and other measurement instruments to which the probe is connected.
 - 9) When using a measurement instrument that does not provide isolation

between its input terminals, chassis, or other input terminals, please pay attention to the following points. If a signal is applied to an input terminal other than that to which the probe is connected, do not connect the ground-side terminal of the signal to any non-ground potential. Otherwise, short-circuit current will flow through the RP1000P or the current probe from the ground terminal, which could cause an electrical accident or damage to the current probe.

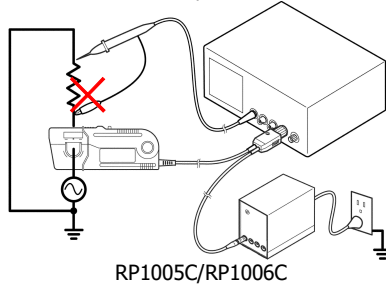
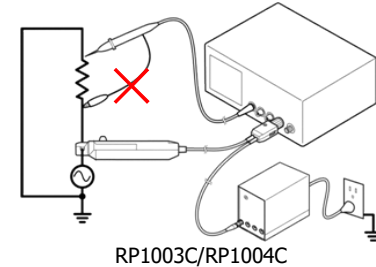

WARNING

1. Do not allow the device to get wet, and do not take measurements with wet hands. This may cause an electric shock.
2. Do not press the demagnetizing switch (DEMAG) to perform demagnetization while the conductor being measured is clamped. Doing so could damage the circuitry or cause an accident that might result in injury or death.
3. Ensure that the input does not exceed the maximum rated current to avoid device damage, short-circuiting and electric shock resulting from heat building.
4. To avoid electric shock when measuring live lines, wear appropriate protective gear, such as insulated rubber gloves, boots and a safety helmet.

CAUTION

RIGOL

1. To avoid damage to the probe, protect it from vibration or shock during transport and handling, and be especially careful to avoid dropping.
2. This probe should be installed and operated indoors only, with temperature between 0°C and 40°C; relative humidity not greater than 80%.
3. Do not store or use the probe where it could be exposed to direct sunlight, high temperature, humidity, or condensation. Under such conditions, its performance specifications may be undermined as its insulation may deteriorate and even worse, the probe may be damaged.
4. This probe is not designed to be entirely water-proof or dust-proof. To avoid damage, do not use it in a wet or dusty environment.
5. The sensor head is a precision assembly that contains a molded component, a ferrite core, and a Hall effect element. It may be damaged if subjected to sudden changes at ambient temperature, or mechanical strain or shock, and therefore great care should be exercised in handling it.
6. The mating surfaces of the sensor head are precision ground, and should be treated with care. If these surfaces are scratched, performance may be impaired.
7. Measurements are degraded by dirt on the mating surfaces of the sensor head, so keep the surfaces clean by gently wiping with a soft cloth.
8. Foreign substances such as dust on the mating surfaces of the sensor head can cause acoustic resonance (refer to the introduction about **resonant sound**) and degrade measurement, so it should be cleaned by gently wiping with a soft cloth.
9. To avoid damaging the sensor cable and power supply cable, do not bend or pull the cables.
10. Do not apply a static electricity or other source of high voltage to the sensor. Doing so may damage its internal Hall elements and circuitry.
11. To clean the probe, wipe it gently with a soft cloth moistened with water or mild detergent. Never use solvents such as benzene, alcohol, acetone, ether, ketones, thinners or gasoline, as they can deform and discolor the case.
12. When the power is on, keep the sensor closed, except when clamping it onto the conductor to be measured. The mating surface of the core section can be scratched while it is open.

13. Keep the sensor head closed when not in use to avoid accumulating dust or dirt on the mating surfaces, as dust accumulation could undermine its clamp performance.
14. Avoid stepping on or pinching the cable to prevent damaging the cable insulation.
15. Keep the cables far away from heat sources, as bare conductors could be exposed if the insulation melts.

NOTE

Correct measurement may be impossible in the presence of strong magnetic fields, such as near transformers and high-current conductors, or in the presence of strong electromagnetic fields such as near radio transmitters.

Service

When sending the probe for repair, pack carefully to prevent damage during transportation. Keep the cushioning materials within the package to avoid the probe to be damaged. Be sure to include details of the problem. **RIGOL** shall not be responsible for damage that occurs during shipment.

A regular calibration is necessary in order to ensure the accuracy performance of the probe. If you need to calibrate the current probe, contact **RIGOL**.

Current Probe Overview

This current probe can be directly connected to a BNC input connector of a waveform measuring instrument. By clamping the sensor head onto a conductor to be measured, the probe can easily capture the current waveforms.

Main Features:

- ◆ Highly accurate current detection
- ◆ Easy current measurement
- ◆ Broadband frequency characteristics
 - RP1003C: DC to 50 MHz
 - RP1004C: DC to 100 MHz
 - RP1005C: DC to 10 MHz
 - RP1006C: DC to 2 MHz
- ◆ RP1003C/RP1004C: Compact design, permits measurement of low current levels
- ◆ RP1005C/RP1006C: Large diameter allows high-current measurements
- ◆ Easy protect function at excessive input
- ◆ Unique thin film Hall effect element

RP1003C/RP1004C Parts Overview

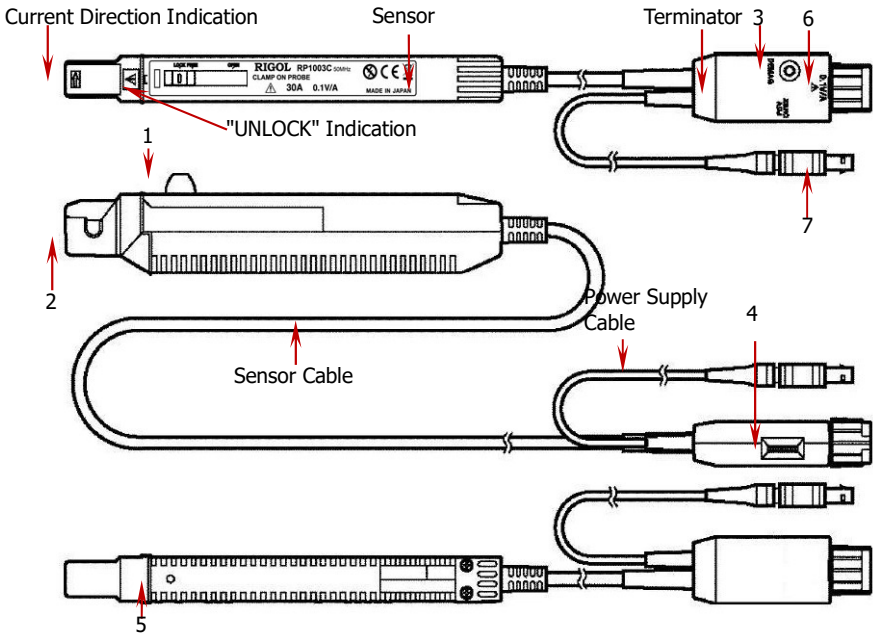

Figure 1 RP1003C/RP1004C Parts

For the parts from 1 to 7 noted in the above figure, please refer to **Parts Introductions**.

RP1005C/RP1006C Parts Overview

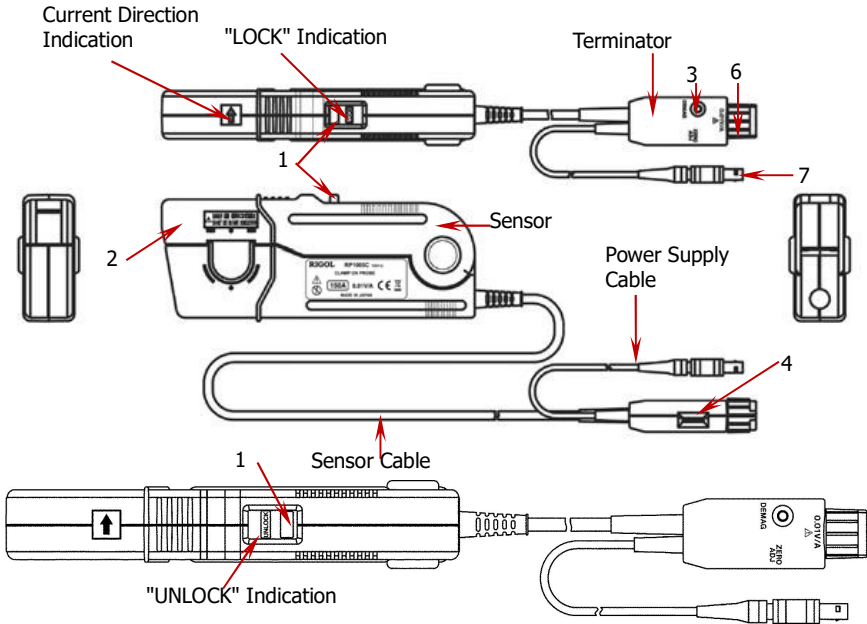

Figure 2 RP1005C/RP1006C Parts

For the parts from 1 to 7 noted in the above figure, please refer to **Parts Introductions**.

Parts Introductions

1. Opening lever

It is used to open and lock the current sensor. You are recommended to lock the current sensor when measuring the conductor to be measured to avoid danger. For RP1003C/RP1004C, there are OPEN, FREE and LOCK indications on one side of the slide switch. The on/off status of the current sensor is related to the position of the slide switch.

- ✧ When the slide switch is in the OPEN position, the current sensor is open and at this point, the conductor to be measured can be connected to the current sensor;
- ✧ When the slide switch is in the FREE position, the current sensor is closed but not locked;
- ✧ When the slide switch is in the LOCK position, the current sensor is locked and at this point, the UNLOCK indication is covered (cannot be seen).

For RP1005C/RP1006C, there are LOCK and UNLOCK indications on the slide switch. The current sensor is locked when the LOCK indication is displayed on the slide switch (the UNLOCK indication disappears).

2. Sensor head

This clamps the conductor being measured, and carries out the actual current measurement. It is a precision assembly that contains a molded component, a ferrite core, and a Hall effect element. It may be damaged if subjected to sudden changes at ambient temperature, or mechanical strain or shock, and therefore great care should be exercised in handling it.

3. Demagnetizing switch (DEMAG)

This demagnetizes the core if it has been magnetized by switching the power on and off, or by an excessive input. Always carry out demagnetizing before measurement.

The demagnetizing process takes about one second (RP1003C/RP1004C) or three seconds (RP1005C/RP1006C).

During demagnetizing, a demagnetizing waveform is output.

4. Zero adjustment dial (ZERO ADJ)

Use the zero adjustment dial to correct the voltage offset or temperature drift on the device. When beginning the measurement, always carry out zero adjustment after demagnetizing.

5. Coarse adjustment trimmer (Only for RP1003C/RP1004C)

Use this only when adjustment is not possible within the range of the zero adjustment dial. Use a nonconductive screwdriver (e.g. ceramic driver) for adjustment.

6. Output connector

The current waveform of the measured conductor is output at a constant rate. The output connector can be connected to the BNC input connector of the waveform measuring instrument.

NOTE

- Since the output resistance is $25\ \Omega$ (RP1003C/RP1004C) or $7\ \Omega$ (RP1005C/RP1006C), the probe must be used with a waveform measurement instrument that has an input impedance of at least $1\ \text{M}\Omega$. Accurate measurement is not possible with the waveform measurement instrument whose input impedance is $50\ \Omega$.
- If using BNC-banana plug adapters or similar to connect to input terminals other than BNC connectors, make sure the polarity is correct.
- Turn the collar until it clicks, and check that it is locked securely.

7. Power plug

Connect this to the power supply receptacle to supply power to the sensor terminator.

To Use the Current Probe

Before using the current probe, make sure to refer to **Safety Precautions**.

Preparations for Measurement

1. Prepare one RP1000P power supply and one waveform measurement instrument for waveform measurement.

CAUTION

Before turning the power supply on, make sure that the voltage matches that indicated on the rear panel of the RP1000P. Connection to an improper supply voltage may damage the RP1000P and present an electrical hazard.

2. Turn the power switch off and connect the power cord.
3. Connect the power plug of the current probe to the power receptacle of the RP1000P.

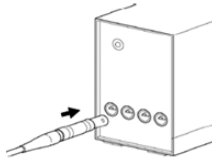

4. Turn the RP1000P power switch on, and check that the front panel power indicator lights on.
5. Wait at least 30 minutes after turning on the current probe. Immediately after power is supplied, offset drift may increase due to the effects of self-heating of the device and other factors. To ensure accurate measurement, wait at least 30 minutes after turning on the current probe before performing the measurement.

Demagnetizing and Zero Adjustment

1. With the waveform measurement instrument input at ground, adjust the trace to the zero position.
2. Set the input coupling of the waveform measurement instrument to DC.
3. Connect the output connector of the current probe to the input connector of the

waveform measurement instrument. Turn the collar until it clicks, and check that it is locked securely.

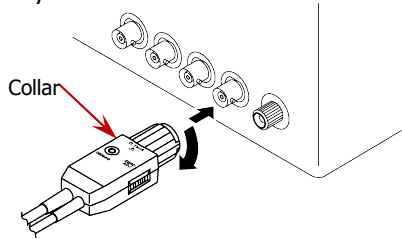

⚠ CAUTION

- When disconnecting the output connector from the waveform measurement instrument, be sure to release the lock before pulling out the connector. Forcibly pulling out the connector without releasing the lock, or pulling the cable, can damage the terminator.
- If using BNC-banana plug adapters or similar to connect to input terminals other than BNC connectors, make sure the polarity is correct.
- Do not demagnetize while the current probe is clamping a conductor to be measured. Demagnetizing causes current to flow into the conductor, which may damage parts in the circuit to be measured.

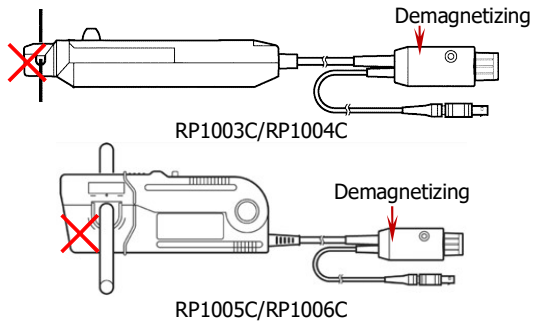

- Check that the conductor being measured is not clamped when supplying power to the current probe for the same reason. Demagnetized waveforms are generated when supplying electric power.
4. Make sure the current sensor is locked (for RP1003C and RP1004C, the slide switch should be in the LOCK position; for RP1005C/RP1006C, LOCK should be displayed on the slide switch and UNLOCK should disappear).
 5. Press the demagnetizing switch (DEMAG) on the terminator.
 6. Turn the zero adjustment dial on the terminator to adjust the trace to the zero position.

NOTE

For RP1003C/RP1004C, if zero adjustment is not possible in Step 6, turn the coarse adjustment trimmer to bring the trace within the range of adjustment by the zero adjustment dial. While turning the coarse adjustment trimmer, do not subject it to a thrust. Doing so may cause the trimmer to come off. To turn the trimmer, use a screwdriver with the following flat blade made of non-conductive materials such as ceramic: 0.4 mm in thickness, 1.8 mm in width, and 10 mm in length or longer.

Measurement Procedure

1. Check that the system is safe, and that the preparations described in the preceding section have been carried out.
2. Open the current sensor by pushing the slide switch in the direction of the arrow as shown in the figure below (for RP1003C/RP1004C, the slide switch should be at the OPEN position; for RP1005C, UNLOCK should be displayed on the slide switch and LOCK should disappear).

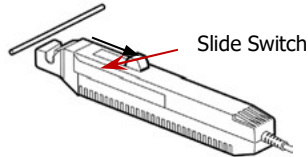

3. Align the sensor so that the current direction indication corresponds to the direction of current flow through the conductor to be measured, and clamp so that the conductor is in the center of the sensor aperture.
4. Lock the current sensor by pushing the slide switch in the direction of the arrow as shown in the figure below (for RP1003C/RP1004C, the slide switch should be in the LOCK position; for RP1005C/RP1006C, you need to first press the current probe to close the current sensor and then push the slide switch until LOCK is displayed and UNLOCK disappears).

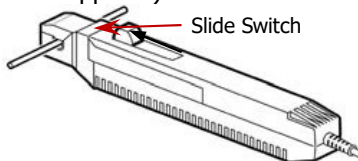

5. It is now possible to monitor the current waveform. The output rate is 0.1 V/A for RP1003C/RP1004C and 0.01 V/A for RP1005C/RP1006C. The current sensitivity can be derived from the voltage sensitivity of the waveform

measurement instrument. For example, for RP1003C, if the voltage sensitivity is 10 mV/div, the current sensitivity is $(10 \text{ mV/div}) / (0.1 \text{ V/A}) = 100 \text{ mA/div}$.

NOTE

- When using the current probe, note that two clamp-on probes may not be used simultaneously with the RP1000P, depending on the current to be measured.
- The current consumption of the current probe depends on the current to be measured. Make sure that the total current consumption of the current probes does not exceed the rated output current of the power supply when multiple current probes are connected to the same power supply. The figure below is the relation curve between the output current and current consumption.

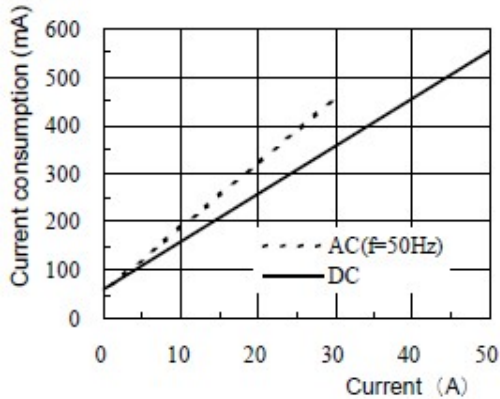

RP1003C

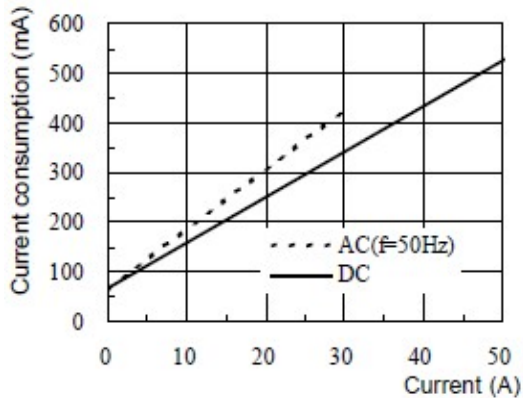

RP1004C

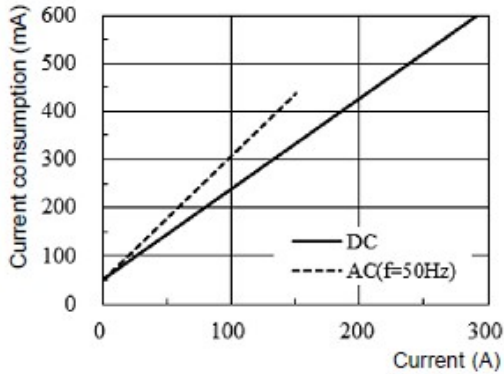

RP1005C

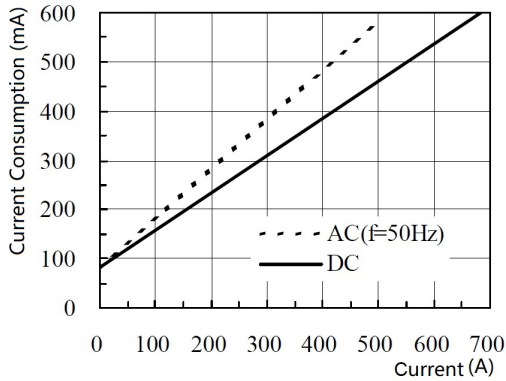

RP1006C

Note: The current consumption is the algebraic sum of the positive and negative current consumption.

Precautions for Measurement

CAUTION

1. The maximum continuous input range is based on the heat that is internally generated during the measurement. Never input current in excess of this level. Exceeding the rated level may result in damage to the probe.
2. The device may sustain damage from self-heating even at current levels that are lower than the maximum current value defined by the maximum rated current.
The maximum rated current is a recommended value that assumes sine-wave

input under standard conditions. Self-heating may increase if the ambient temperature increases or the measurement current waveform contains other frequency components. Refer to **Appendix 2 Relation between Max Input Current and Frequency**.

3. If excess current is input, generated heat activates a built-in safety function that blocks normal output. If this happens, remove the input immediately (remove the sensor from the conductor being measured, or reduce the input current to zero). Wait until the sensor has had sufficient time to cool before resuming operation.
4. Heating generated during measurement of the current with a frequency of 1 kHz or higher is mainly attributed to the self-heating of the sensor head. In this case, the built-in safety function will not be activated. Be careful to avoid accidents, such as a burn by heat, short-circuit, and damage to the sensor.
5. Even if the input current does not exceed the rated continuous input range, continuous input for an extended period of time may result in activation of the safety circuit to prevent damage resulting from heating of the sensor.
6. At high ambient temperature, the built-in safety circuit may activate at current input levels below the rated continuous input range.
7. Continuous input of current exceeding the continuous input range or repeated activation of the safety function may result in damage to the device.
8. The maximum input range is indicated by the **Maximum Continuous Input Range**. It is also indicated by another product specification **Maximum Peak Current Value**. Make sure that the input does not exceed the continuous maximum input range in rms.
9. Do not place any unclamped conductor with an electric current of a frequency of 10 kHz or higher near the sensor head. Current flowing in the conductor nearby may heat up the sensor head and cause its temperature to rise, leading to damage to the sensor.

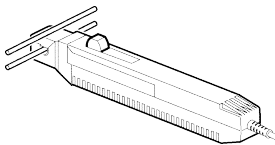

RP1003C/RP1004C

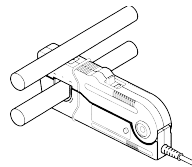

RP1005C/RP1006C

10. When opening the sensor head of the probe, be sure to operate with the

opening lever. For RP1003C/RP1004C, if an upper core is forced to open, when the sensor head is locked, the open-close mechanism can be damaged.

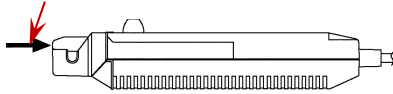
**NOTE**

1. Immediately after being powered on, the probe may be subject to an appreciable offset drift due to self-heating. To counteract this, allow the probe to warm up for about 30 minutes before carrying out measurement.
2. When performing continuous measurements, it is necessary to be aware that the offset voltage drifts, depending on factors such as the ambient temperature.
3. Under certain circumstances, oscillation may occur if the probe is connected to the power supply while the power supply is on. This does not indicate a malfunction. Oscillation can be stopped and operation restored to normal by opening and closing the clamp.
4. Depending on the amplitude and frequency of the current being measured, the sensor head may emit a resonant sound. This sound may also occur during demagnetizing operation, but it does not represent a malfunction (device failure).
5. If foreign matter becomes adhered to the mating surfaces on the sensor head so that a slight gap exists between the upper and lower sensors, the sensor head may emit a resonant sound. Any foreign matter should be removed using the cleaning method described in this manual.
6. An increase in the volume of the resonant sound during use may indicate that the gap between the upper and lower sensors has increased in size. Since the sensor characteristics may change, it is recommended to calibrate the device.
7. Pressing the demagnetizing switch (DEMAG) will cause a demagnetized waveform to be output from the instrument. Although it may be asymmetry with respect to the zero-volt line, the instrument has no malfunction.
8. The reading may be affected by the position within the clamp aperture of the conductor being measured. The conductor should be in the center of the clamp aperture.
9. When carrying out measurement, make sure the sensor head is locked (for RP1003C/RP1004C, the slide switch should be in the LOCK position; for

RP1005C/RP1006C, press the slider on the sensor head until the "UNLOCK" indication disappears, and hold it until LOCK appears). If the sensor head is not properly closed, accurate measurement will not be possible.

10. Accurate measurement may be impossible in locations subject to strong external magnetic fields, such as transformers and high current conductors, or in locations subject to strong external electric fields, such as radio transmission equipment.
11. At high frequencies, common mode noise may affect measurements taken on the high voltage side of circuits. If this occurs, reduce the frequency range of the waveform measuring instrument, or clamp onto the low-voltage side of the circuit, as appropriate.

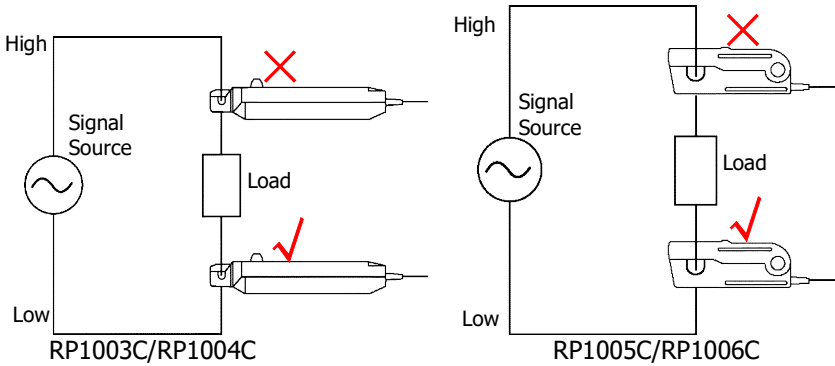

Specifications

When the probe works for at least 30 minutes at 23°C±5°C, the following specifications can be guaranteed.

RP1003C/RP1004C

Bandwidth	RP1003C: DC to 50 MHz (-3 dB), refer to Appendix 1 Amplitude-frequency Characteristics (RP1003C) RP1004C: DC to 100 MHz (-3 dB), refer to Appendix 1 Amplitude-frequency Characteristics (RP1004C)
Rise Time	RP1003C: ≤7 ns RP1004C: ≤3.5 ns
Maximum Continuous Input Range	30 Arms, refer to Appendix 2 Relation between Max Input Current and Frequency (RP1003C/RP1004C)
Maximum Peak Current Value	Non-continuous 50 A peak
Gain	0.1 V/A
Amplitude Accuracy	±1.0%rdg±1 mV, ≤30 Arms ±2.0%rdg, ≤50 A peak (DC, 45 Hz to 66 Hz, input within continuous maximum input range)
Noise	≤2.5 mArms (for BW 20 MHz waveform measuring instrument)
Input Impedance	Refer to Appendix 3 Input Impedance (Typical) (RP1003C/RP1004C)
Temperature Coefficient for Sensitivity	≤±2% (during input of 50 Hz, 30 Arms within range of 0°C to 40°C)
Maximum Rated Power	5.3 VA
Rated Supply Voltage	+12 V±0.5 V
Operating Temperature and Humidity Range	0°C to 40°C, ≤80% RH (no condensation)
Storage Temperature and Humidity Range	-10°C to +50°C, ≤80% RH (no condensation)

Location for Use	Indoor, altitude up to 2,000 m, Pollution Degree 2
Effect of External Magnetic Fields	RP1003C: ≤ 20 mA (DC and 60 Hz, magnetic field of 400 A/m) RP1004C: ≤ 5 mA (DC and 60 Hz, magnetic field of 400 A/m)
Diameter of Measurable Conductor	5 mm
Measurable Conductor	Insulated conductor
Guaranteed Accuracy Period	1 year (opening/closing up to 10,000 times)
Cable Length	Sensor cable: approx. 1.5 m Power supply cable: approx. 1 m
External Dimension	Sensor: approx. 175W \times 18H \times 40D (mm) (excluding protrusions) Terminator: approx. 27H \times 55W \times 18D (mm)
Mass	RP1003C: approx. 230g RP1004C: approx. 240g
Accessories	User Guide, Probe Case
Safety	EN61010
EMC	EN61326

RP1005C

Bandwidth	DC to 10 MHz (-3 dB), refer to Appendix 1 Amplitude-frequency Characteristics (RP1005C)
Rise Time	≤ 35 ns
Maximum Continuous Input Range	150 Arms, refer to Appendix 2 Relation between Max Input Current and Frequency (RP1005C)
Maximum Peak Current Value	300A peak, non-continuous 500A peak, pulse width $\leq 30\mu$ s
Gain	0.01 V/A
Amplitude Accuracy	$\pm 1.0\%$ rdg ± 1 mV, ≤ 150 Arms $\pm 2.0\%$ rdg, 150 A to 300 A peak (DC, 45 Hz to 66 Hz)
Noise	≤ 25 mArms (for BW 20MHz waveform measuring instrument)
Input Impedance	Refer to Appendix 3 Input Impedance (Typical) (RP1005C)
Temperature	$\leq \pm 2\%$ (during input of 55 Hz, 150 Arms within

RIGOL

Coefficient for Sensitivity	range of 0°C to 40°C)
Maximum Rated Power	5.5 VA (within maximum continuous input range)
Rated Supply Voltage	+12 V±1 V
Operating Temperature and Humidity Range	0°C to 40°C, ≤80% RH (no condensation)
Storage Temperature and Humidity Range	-10°C to +50°C, ≤80% RH (no condensation)
Location for Use	Indoor, altitude up to 2,000 m, Pollution Degree 2
Period of Guaranteed Accuracy	1 year (opening/closing up to 10,000 times)
Effect of External Magnetic Fields	≤150 mA (in a DC or 60 Hz, 400 A/m magnetic field)
Diameter of Measurable Conductor	20 mm
Measurable Conductor	Insulated conductor
Cable Length	Sensor cable: approx. 2 m Power supply cable: approx. 1 m
External Dimension	Sensor: approx. 176W X 69H X 27D (mm) Terminator: approx. 27H X 55W X 18D (mm)
Mass	Approx. 500g
Accessories	User Guide, Probe Case
Safety	EN61010
EMC	EN61326

RP1006C

Bandwidth	DC to 2 MHz (-3 dB), refer to Appendix 1 Amplitude-frequency Characteristics (RP1006C)
Rise Time	≤175 ns
Maximum Continuous Input Range	500 Arms, refer to Appendix 2 Relation between Max Input Current and Frequency (RP1006C)

Maximum Peak Current Value	700A peak, non-continuous
Gain	0.01 V/A
Amplitude Accuracy	$\pm 1.0\%$ rdg ± 5 mV, ≤ 500 Arms $\pm 2.0\%$ rdg, ≤ 700 A peak (DC, 45 Hz to 66 Hz)
Noise	≤ 25 mArms (for BW 20MHz waveform measuring instrument)
Input Impedance	Refer to Appendix 3 Input Impedance (Typical) (RP1006C)
Temperature Coefficient for Sensitivity	$\leq \pm 2\%$ (during input of 50 Hz, 500 Arms within range of 0°C to 40°C)
Maximum Rated Power	7.2 VA (within maximum continuous input range)
Rated Supply Voltage	+12 V ± 0.5 V
Operating Temperature and Humidity Range	0°C to 40°C, $\leq 80\%$ RH (no condensation)
Storage Temperature and Humidity Range	-10°C to +50°C, $\leq 80\%$ RH (no condensation)
Location for Use	Indoor, altitude up to 2,000 m, Pollution Degree 2
Period of Guaranteed Accuracy	1 year (opening/closing up to 10,000 times)
Effect of External Magnetic Fields	≤ 800 mA (in a DC or 60 Hz, 400 A/m magnetic field)
Diameter of Measurable Conductor	20 mm
Measurable Conductor	Insulated conductor
Cable Length	Sensor cable: approx. 2 m Power supply cable: approx. 1 m
External Dimension	Sensor: approx. 176W X 69H X 27D (mm) Terminator: approx. 27H X 55W X 18D (mm)
Mass	Approx. 520g
Accessories	Probe Case
Safety	EN61010
EMC	EN61326

Appendix

Appendix 1 Amplitude-frequency Characteristics

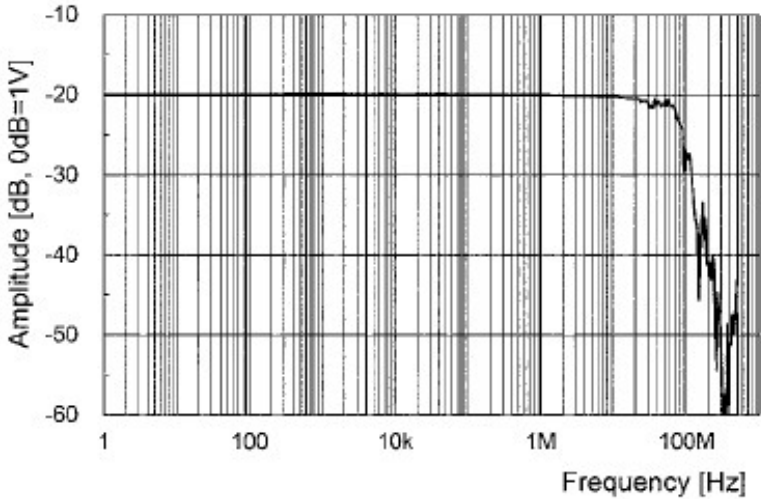

RP1003C

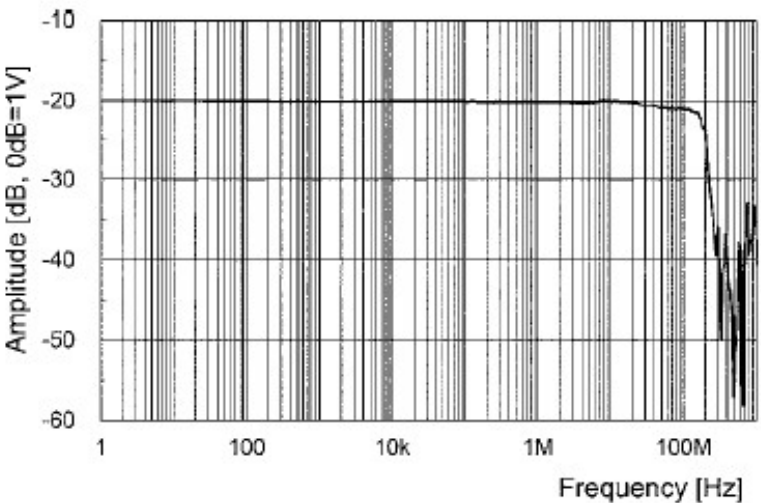

RP1004C

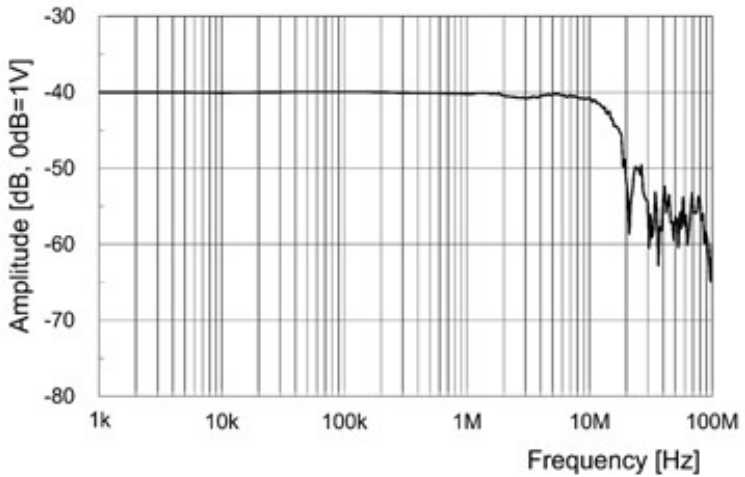
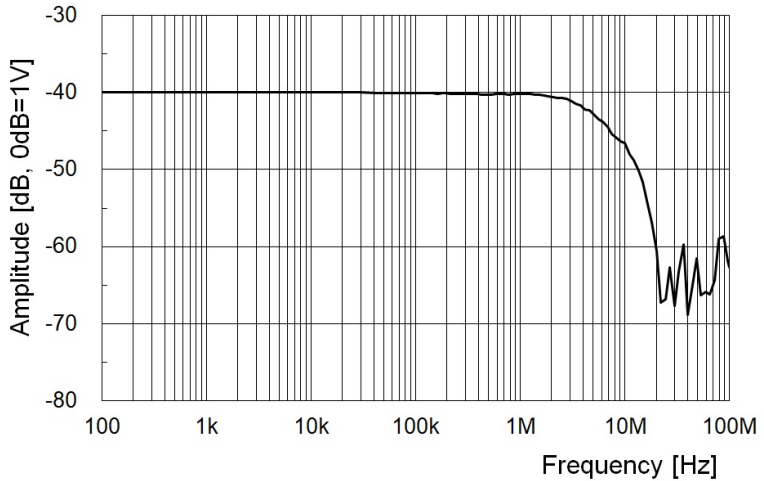
**RP1005C****RP1006C**

Appendix 2 Relation between Max Input Current and Frequency

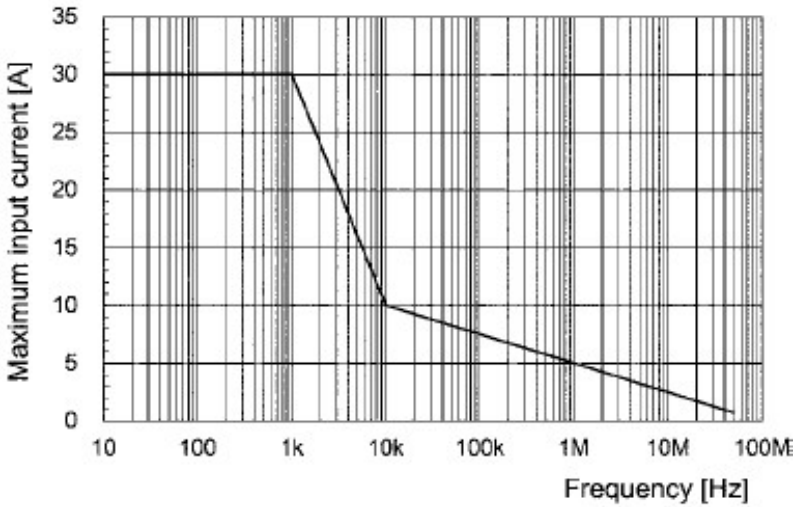

RP1003C

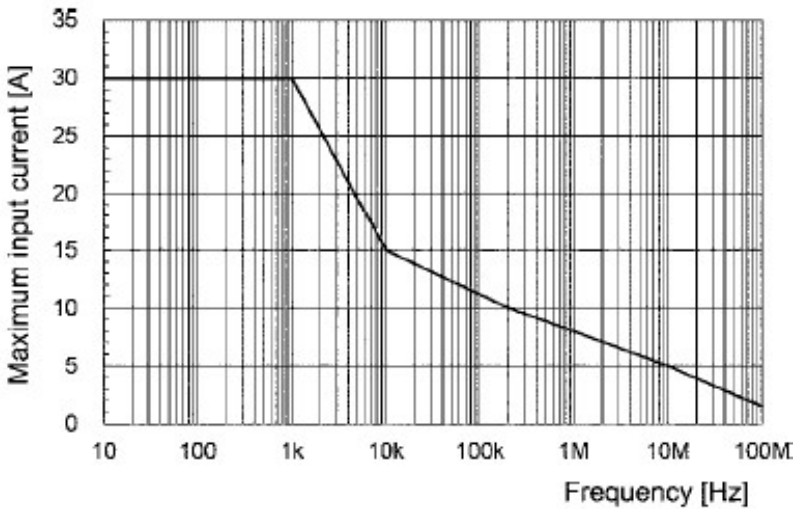

RP1004C

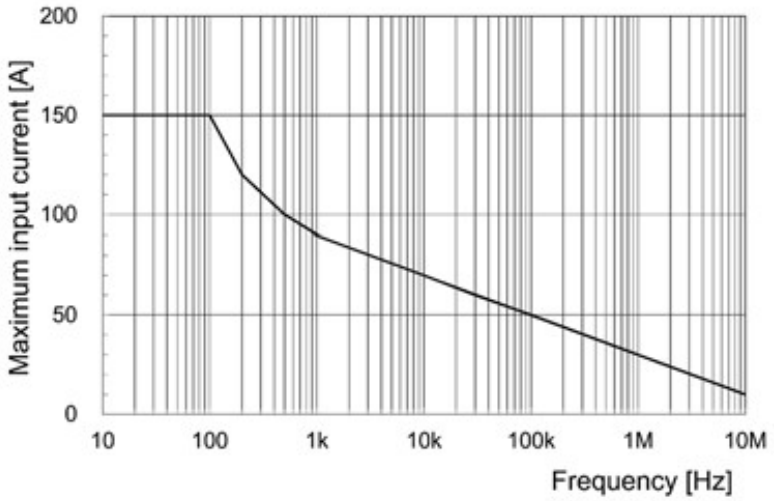
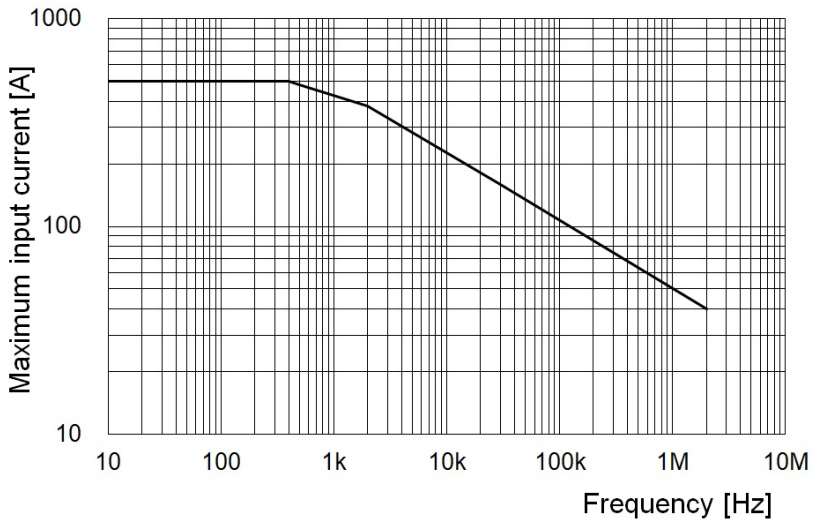
**RP1005C****RP1006C**

Appendix 3 Input Impedance (Typical)

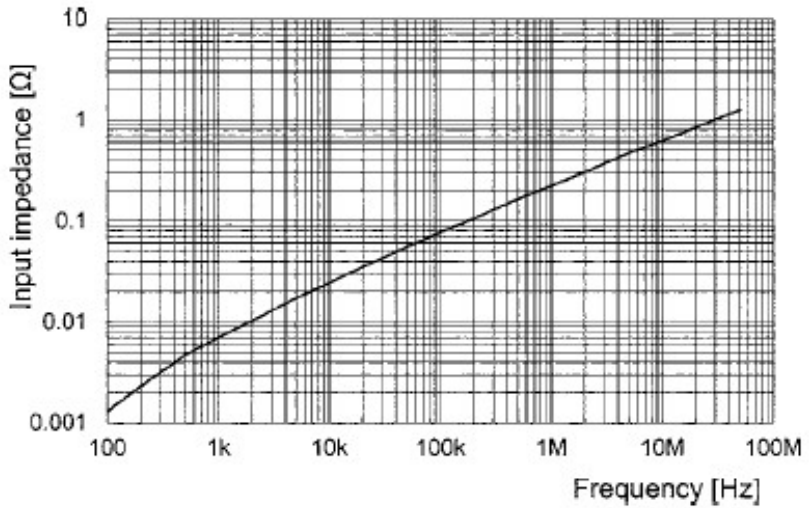

RP1003C

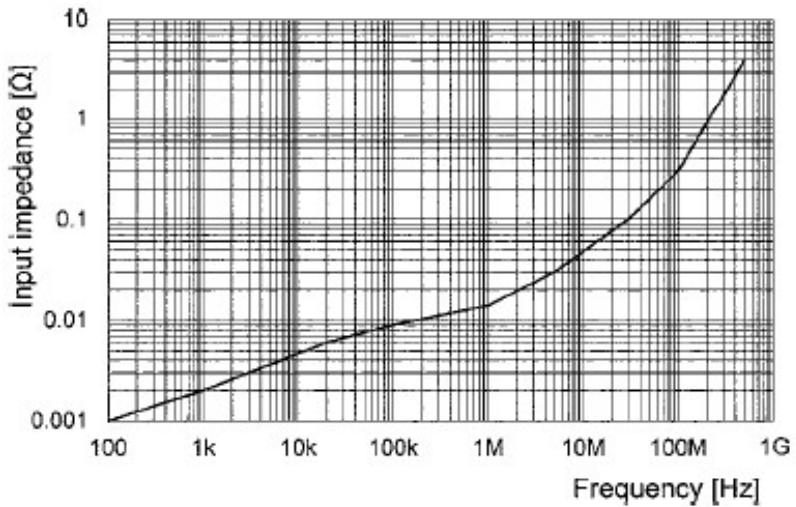

RP1004C

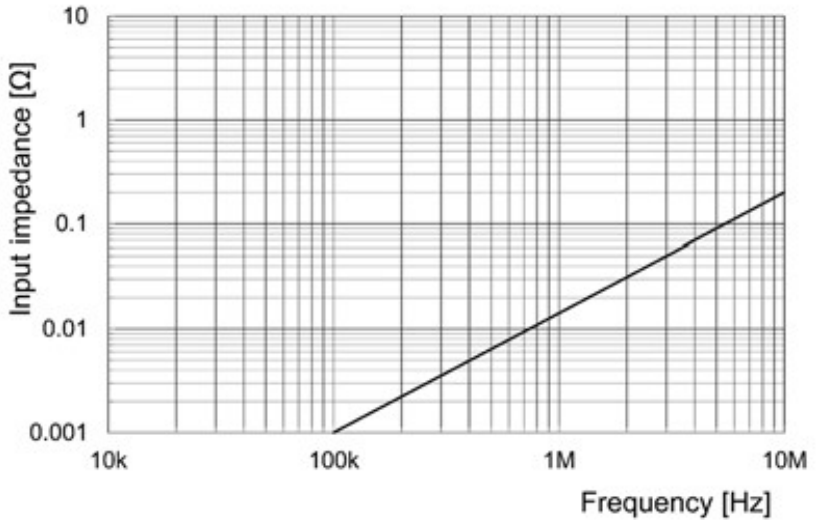
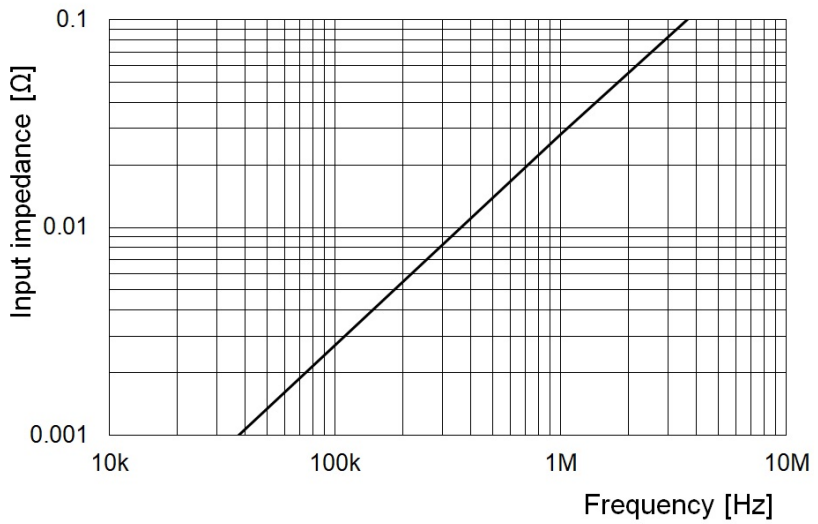
**RP1005C****RP1006C**